



**Home Theater Seating**  
 18124 Wedge Parkway  
 suite 1007  
 Reno, Nevada 89511-8134  
 406-322-2000  
 www.premierehts.com

# Alamo

05/01/2015

## Standard / Ottomans / Armless

## 2-Piece Curve Sectional

Put Green Arrows with Red Arrows to Create Sectional Groups

Put Blue Arrows with Yellow Arrows to Create Sectional Groups or Green Arrows with Red Arrows to mix with some of the L-Shaped pieces.

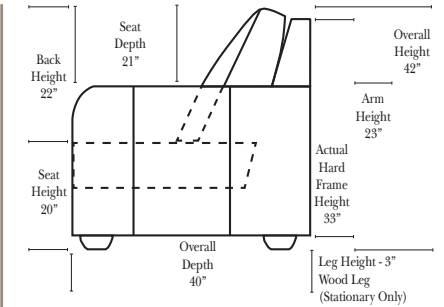
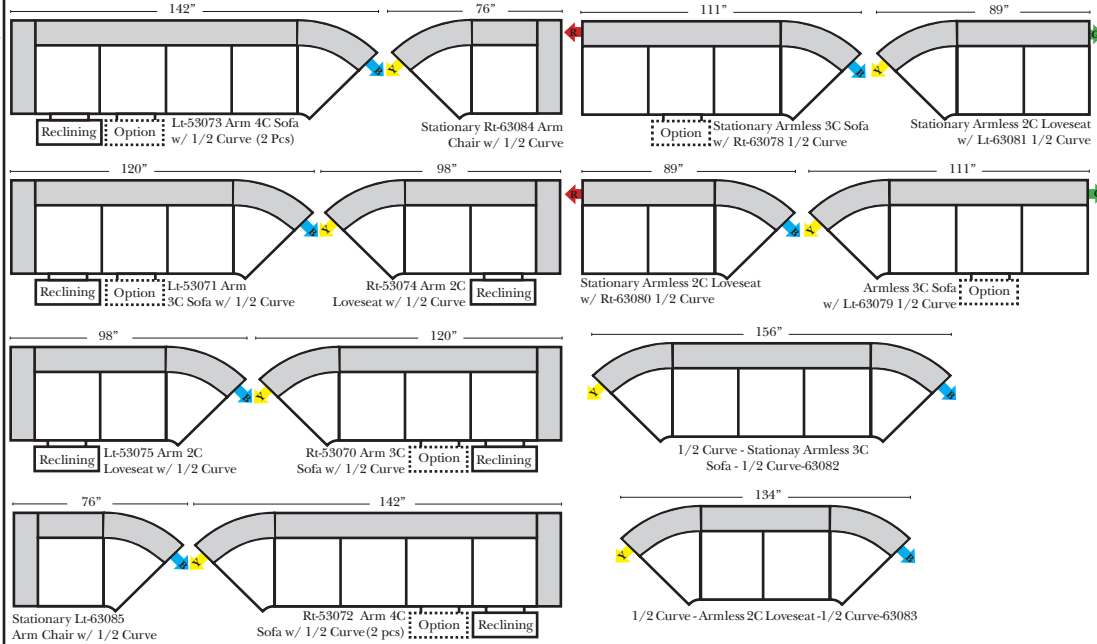
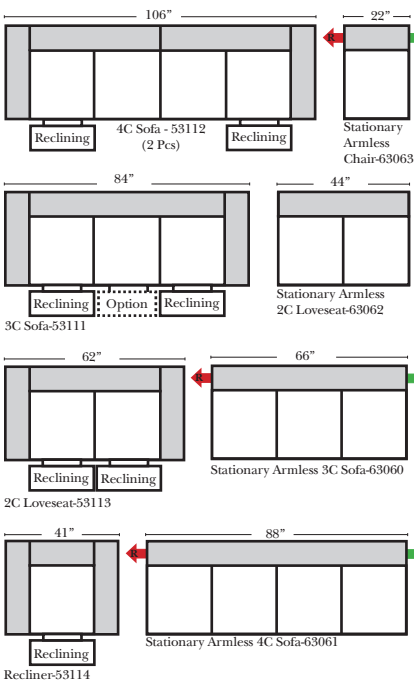

### Standards & Options

#### Standard:

- Available in Full & Top Grain Leathers
- Available in Luxury Fabrics
- All Hardwood Frames
- Nail Heads - Brass
- Wood Leg Finish - Walnut Finish (Stationary Only)

#### Options: (No Additional Charge)

- No. 33 Firm Foam
- Wood Leg - Cherry, Chocolate, Espresso, Honey Oak, Shadow

#### Options: (Additional Charges Apply)

- Console Table - Standard as Espresso finish (N/C Option is Honey Oak finish)
- Metal Cup Holder (MCH) - Standard Finish is Silver (N/C Option is Black or Hammered Antique Finish)
- Electronic Cup Holder (ECH) Console Arms Only (Available with Motorized Reclining Seats only)
- Sofa Center Recliner
- Motorized Recliner Mechanism
- Swivel Recliner Base
- Swivel Glider Mechanism
- Lift Chair Dual Motor Mechanism

#### Sleeper Options: (Additional charges apply)

- Full Sleeper available w/Standard Mattress
- Deluxe Innerspring Mattress: Full
- Air Dream Coil Mattress: Full Only



**Note:**  
 All Dimensions are approximate, if accuracy is crucial, please contact us for validation of the dimensions shown. However, a 1" to 2" variance can still apply due to foam and upholstery.

All items on these pages are available as Stationary (Non-Reclining)

## 90 Degree / L-Shape Sectional

Put Green Arrows with Red Arrows to Create Sectional Groups

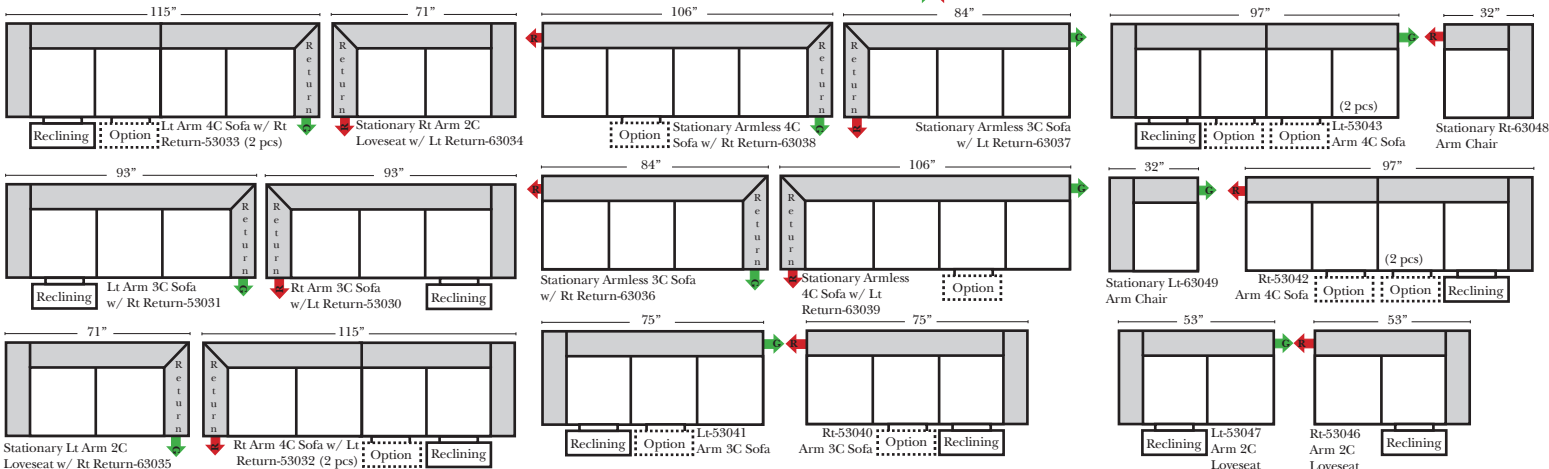

## Bumper / Return Chaise & Conversation Sofas

Put Green Arrows with Red Arrows to Create Sectional Groups  
Put Orange Arrows with Tan Arrows to Create Sectional Groups

Put Blue Arrows with Yellow Arrows to Create Sectional Groups

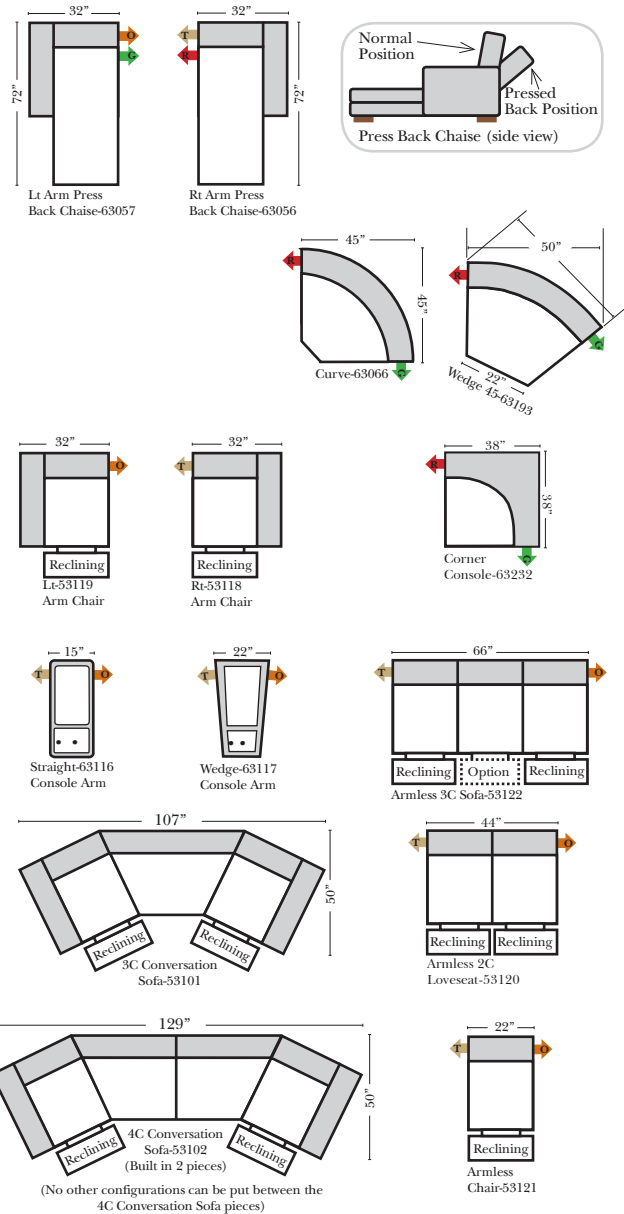

## Sleepers

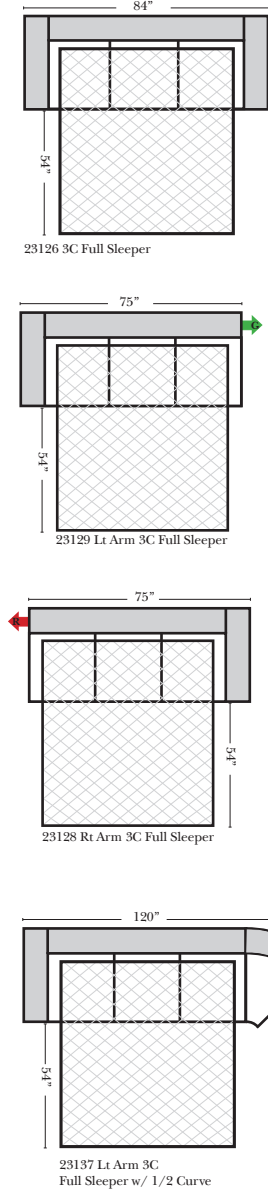

## Suggested Configurations

05/01/2015

The Suggested Configurations below are only a sample of what the imagination can create, please enjoy creating the configuration that fits your lifestyle, using the ideas below and from the items on the opposite page.

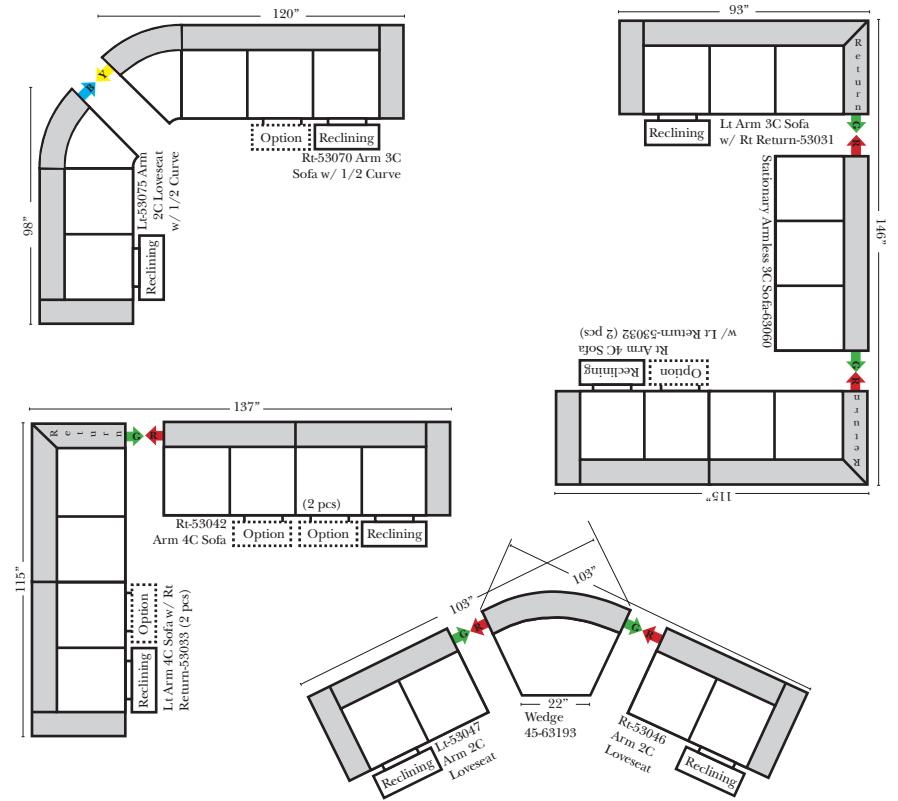

## Sleepers (cont.)

