

## Standard / Armless

Put Green or Orange Arrows with Red or Tan Arrows to Create Sectional Groups

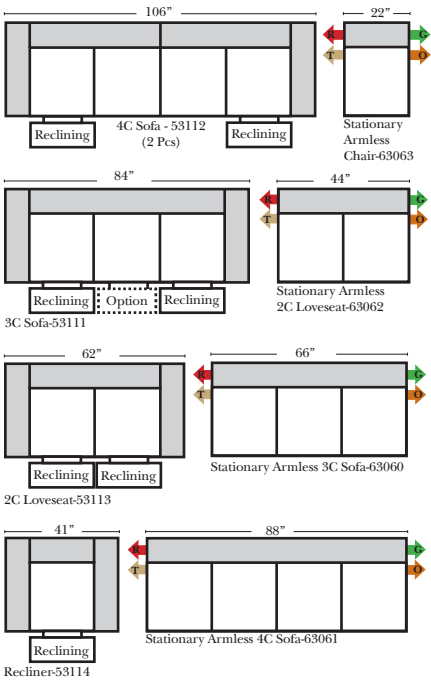

## 2-Piece Curve Sectional

Put Blue Arrows with Yellow Arrows to Create Sectional Groups or Green Arrows with Red Arrows to mix with some of the L-Shaped pieces.

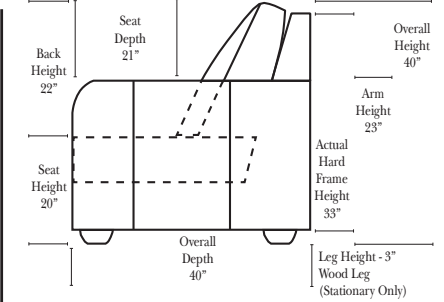
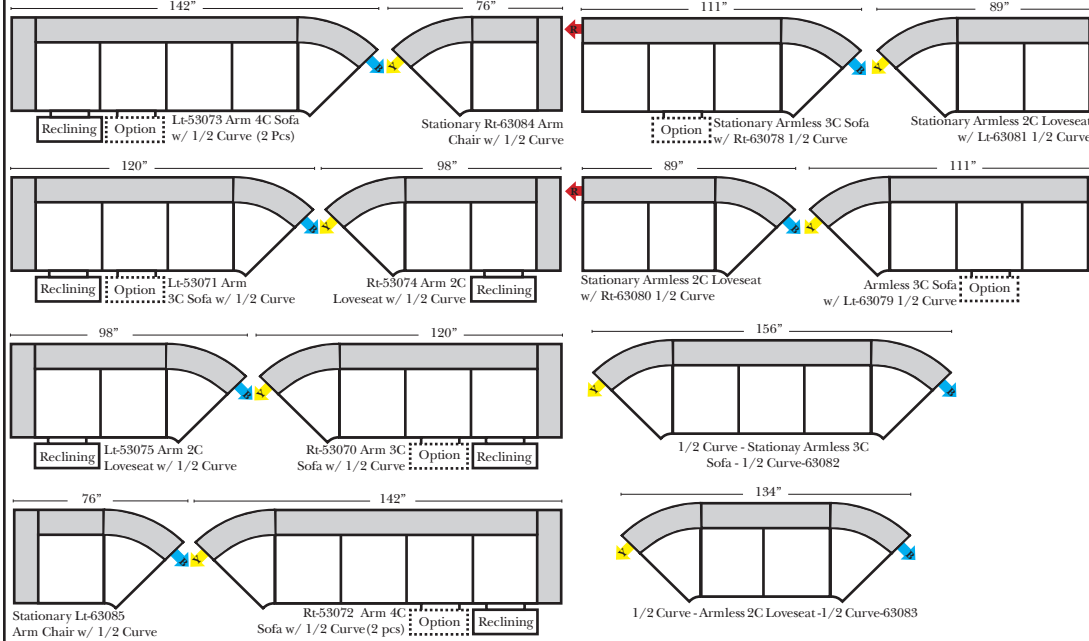

### Standards & Options

- Standard:**
- Available in Full & Top Grain Leathers
  - Available in Luxury Fabrics
  - All Hardwood Frames
  - Nail Heads
  - Wood Leg Finish - Walnut Finish (Stationary Only)
- Options: (No Additional Charge)**
- No. 33 Firm Foam
  - Wood Leg - Cherry, Chocolate, Espresso, Honey Oak, Shadow (Stationary Only)

- Options: (Additional Charges Apply)**
- Console Table - Standard as Espresso finish (N/C Option is Honey Oak finish)
  - Metal Cup Holder (MCH) - Standard Finish is Silver (N/C Option is Black or Hammered Antique Finish)
  - Electronic Cup Holder (ECH) (Console Arms Only) (Available with Motorized Reclining Seats only)
  - Center Seat Recliner (Option)
  - Motorized Recliner Mechanism
  - Swivel Recliner Base (2 Arm Recliner Only)
  - Swivel Glider Mechanism (2 Arm Recliner Only)
  - Glider Mechanism Only (2 Arm Recliner Only)
  - Lift Chair Dual Motor Mechanism (2 Arm Recliner Only)
  - Upholstered Swivel Base (2 Arm Recliner Only)
  - Motorized 180° Swivel Glider (2 Arm Recliner Only)

- Sleeper Options: (Additional charges apply)**
- Full Sleeper available w/Standard Mattress
  - Deluxe Innerspring Mattress: Full
  - Air Dream Coil Mattress: Full Only



**Note:**  
All Dimensions are approximate, if accuracy is crucial, please contact us for validation of the dimensions shown. However, a 1" to 2" variance can still apply due to foam and upholstery.

All items on these pages are available as Stationary (Non-Reclining)

## 90 Degree / L-Shape Sectional

Put Green or Orange Arrows with Red or Tan Arrows to Create Sectional Groups

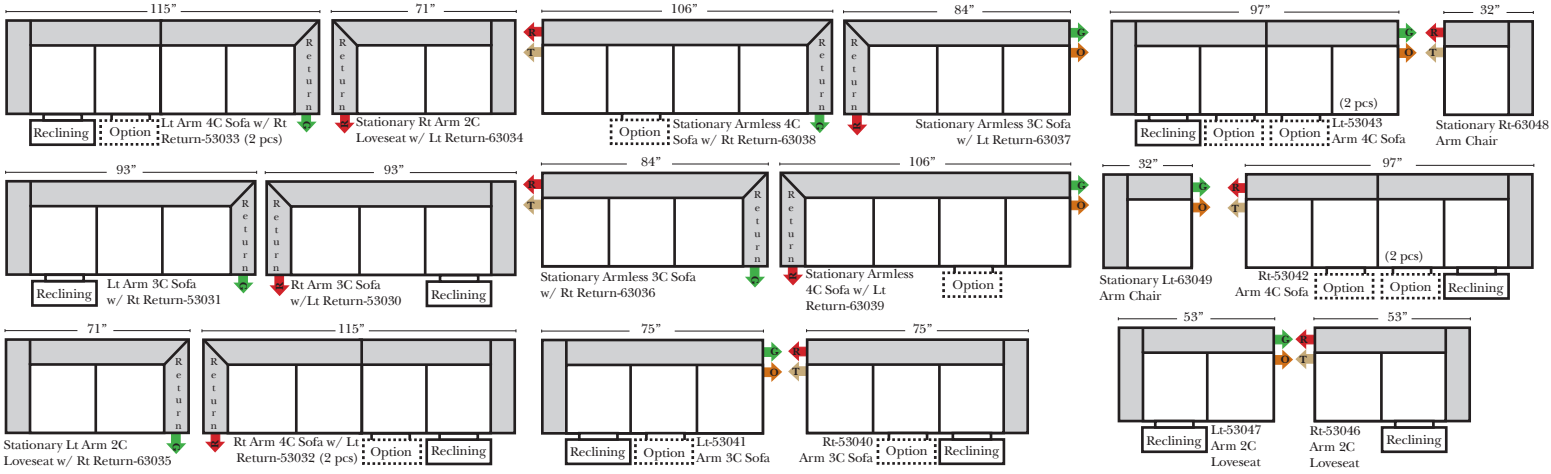



**Home Theater Seating**  
 18124 Wedge Parkway  
 suite 1007  
 Reno, Nevada 89511-8134  
 406-322-2000  
 www.premierehts.com

# Sundance

## Bumper / Return Chaise & Conversation Sofas

Put Green Arrows with Red Arrows to Create Sectional Groups  
 Put Orange Arrows with Tan Arrows to Create Sectional Groups

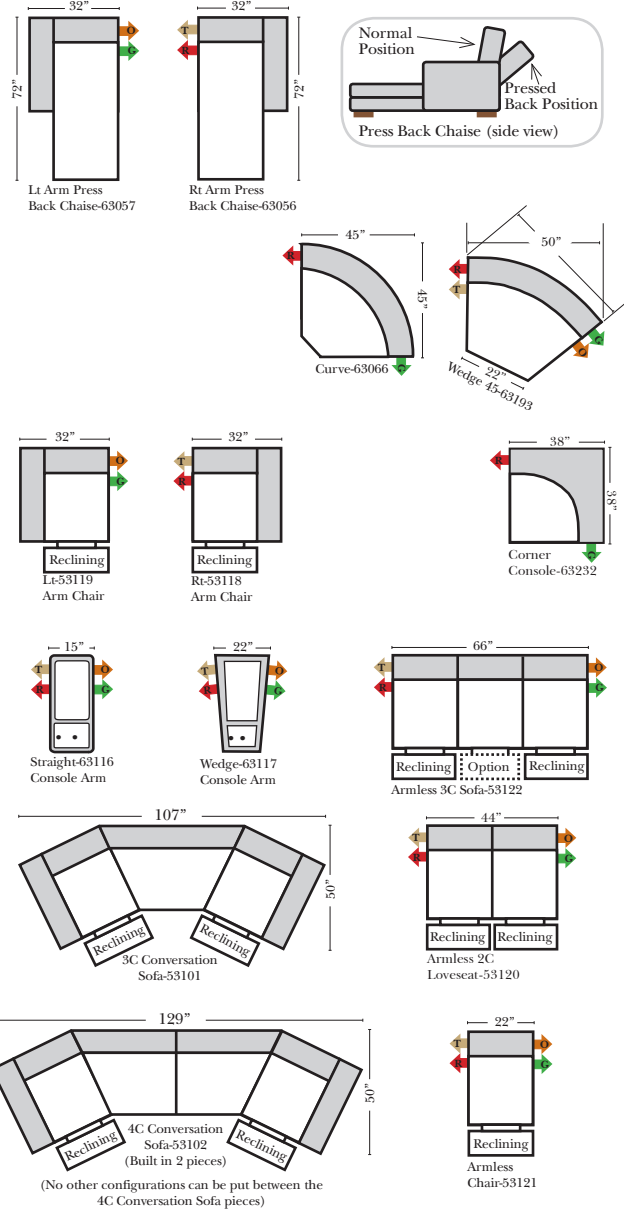

## Sleepers

Put Blue Arrows with Yellow Arrows to Create Sectional Groups

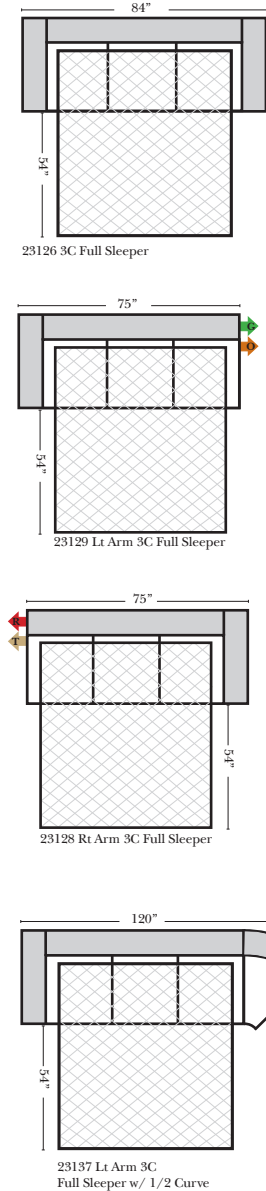

## Suggested Configurations

05/01/2015

The Suggested Configurations below are only a sample of what the imagination can create, please enjoy creating the configuration that fits your lifestyle, using the ideas below and from the items on the opposite page.

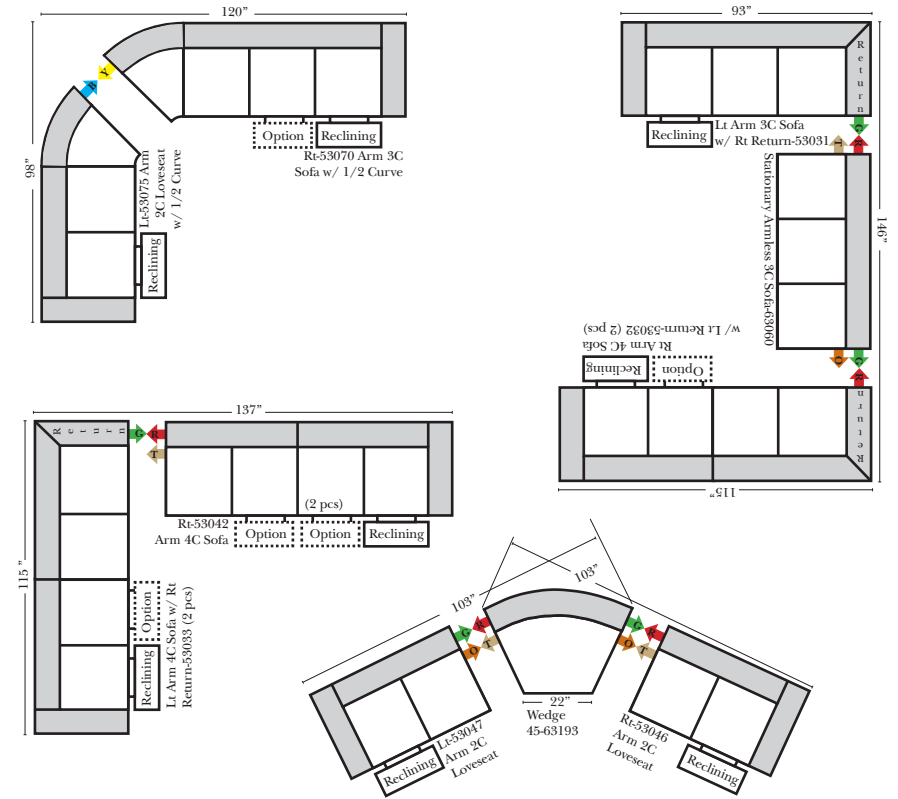

## Sleepers (cont.)

